

G0542 Parts Breakdown and List

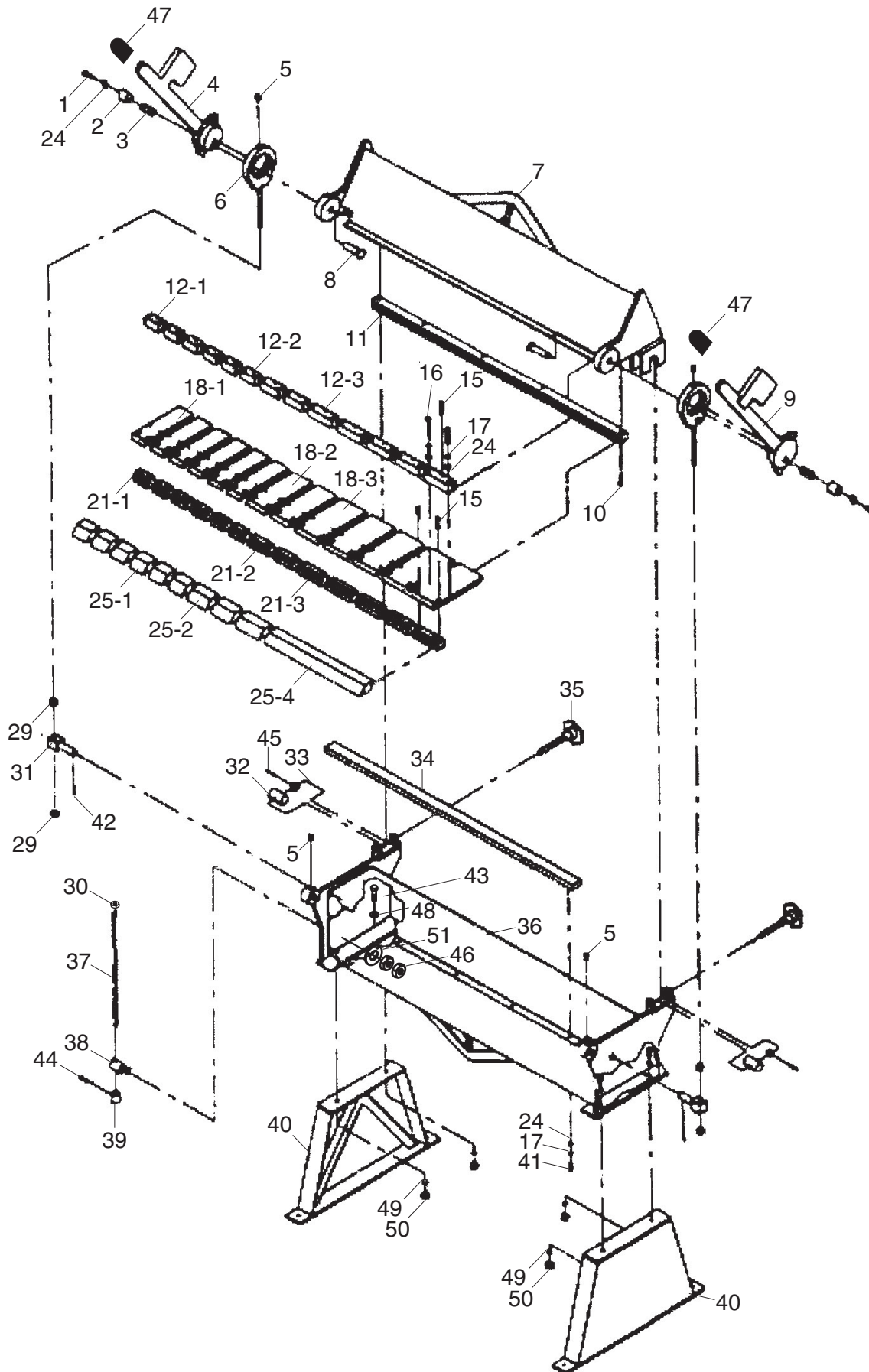

REF	PART #	DESCRIPTION
1	PB01M	HEX NUT M10-1.5 X 30
2	P0542002	SPACER
3	P0542003	SPRING
4	P0542004	CLAMPING HANDLE (L)
5	P0542005	OIL FITTING
6	P0542006	LINK
7	P0542007	CLAMPING LEAF
8	P0542008	PIN
9	P0542009	CLAMPING HANDLE (R)
10	PSB47M	CAP SCREW M10-1.5 X 40
11	P0542011	SUPPORT BLOCK
12-1	P0542012-1	3" UPPER CLAMP BAR
12-2	P0542012-2	4" UPPER CLAMP BAR
12-3	P0542012-3	5" UPPER CLAMP BAR
15	PSB72M	CAP SCREW M10-1.5 X 30
16	PSB71M	CAP SCREW M10-1.5 X 60
17	PLW06M	LOCK WASHER 10MM
18-1	P0542018-1	3" FINGER BLOCK JAW
18-2	P0542018-2	4" FINGER BLOCK JAW
18-3	P0542018-3	5" FINGER BLOCK JAW
21-1	P0542021-1	3" LOWER CLAMP BAR
21-2	P0542021-2	4" LOWER CLAMP BAR
21-3	P0542021-3	5" LOWER CLAMP BAR
24	PW04M	FLAT WASHER 10MM
25-1	P0542025-1	3" FINGER BLOCK

REF	PART #	DESCRIPTION
25-2	P0542025-2	4" FINGER BLOCK
25-4	P0542025-4	25" FINGER BLOCK
29	PN15M	HEX NUT M18-1.5
30	PN02M	HEX NUT M10-1.5
31	P0542031	PIVOT BLOCK
32	P0542032	ADJUSTING BLOCK
33	P0542033	COLLAR
34	P0542034	TOP BAR
35	P0542035	SETBACK KNOB M20 X 150
36	P0542036	BODY
37	P0542037	STOP ROD
38	P0542038	STOP HUB
39	P0542039	STOP COLLAR
40	P0542040	SUPPORT
41	PSB84M	CAP SCREW M10-1.5 X 35
42	P0542042	COTTER PIN 2.5 X 35MM
43	PB35M	HEX BOLT M12-1.5 X 40
44	P0542044	T-BOLT M8-1.25 X 20
45	P0542045	TAPER PIN 4 X 4.6 X 30M
46	PN13M	HEX NUT M16-2
47	P0542047	RUBBER HANDLE GRIP
48	PW06M	FLAT WASHER 12MM
49	PLW05M	LOCK WASHER 12MM
50	PN09M	HEX NUT M12-1.75
51	PW08M	FLAT WASHER 16MM

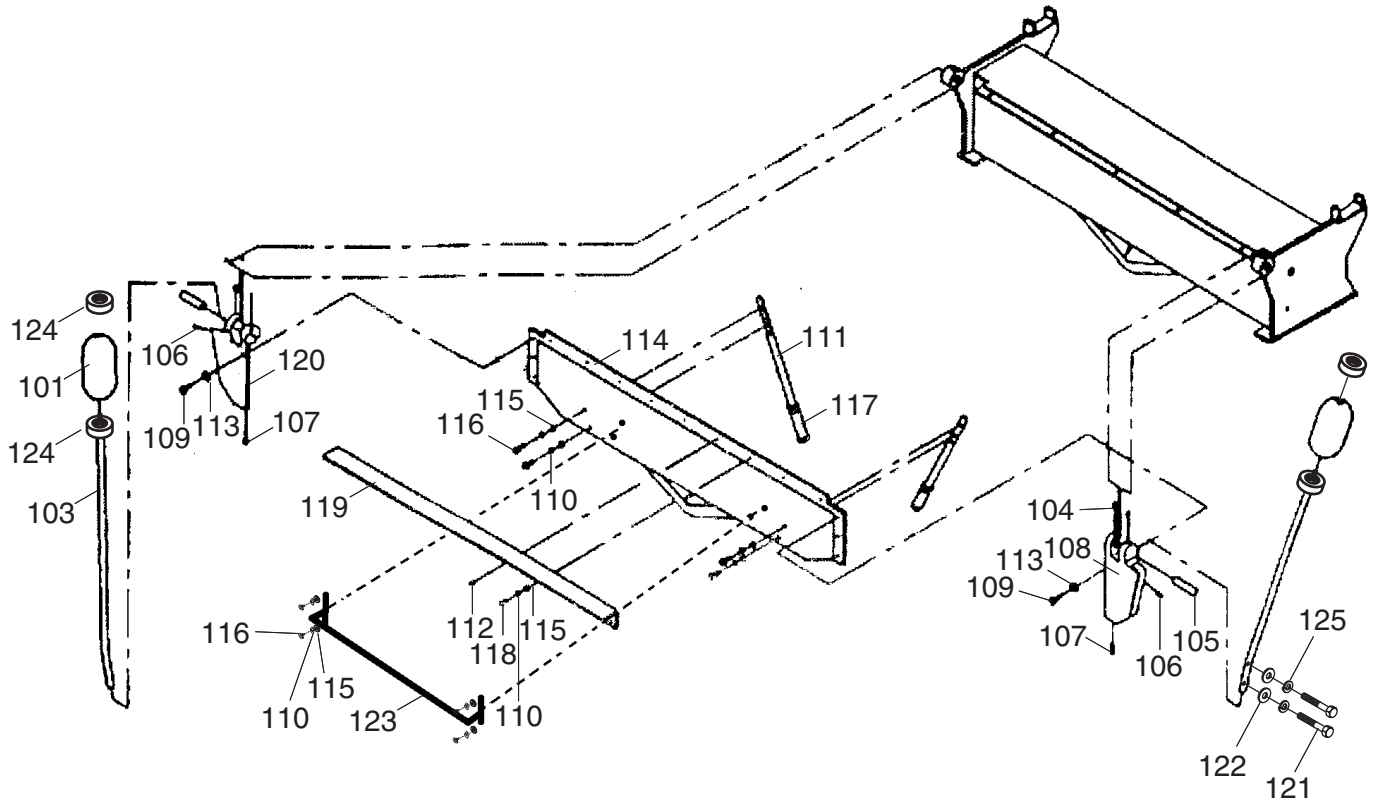

REF	PART #	DESCRIPTION
101	P0542101	COUNTERWEIGHT
103	P0542103	COUNTERWEIGHT SHAFT
104	PSS30M	SET SCREW M10-1.5 X 10
105	P0542105	PIVOT PIN
106	PSS77M	SET SCREW M12-1.75 X 20
107	PSB47M	CAP SCREW M10-1.5 X 40
108	P0542108	RIGHT HINGE
109	PB35M	HEX BOLT M12-1.75 X 40
110	PLW06M	LOCK WASHER 10MM
111	P0542111	OPERATING HANDLE
112	P0542112	DOWEL PIN 8 X 30MM
113	PW06M	FLAT WASHER 12MM

REF	PART #	DESCRIPTION
114	P0542114	BENDING LEAF
115	PW04M	FLAT WASHER 10MM
116	PB31M	HEX BOLT M10-1.5 X 40
117	P0542117	HANDLE GRIP
118	PSB72M	CAP SCREW M10-1.5 X 30
119	P0542119	BENDING WING
120	P0542120	LEFT HINGE
121	PB35M	HEX BOLT M12-1.75 X 40
122	PW06M	FLAT WASHER 12MM
123	P0542123	HANDLEBAR
124	P0542124	LOCK COLLAR M30-3.5
125	PLW05M	LOCK WASHER 12MM