

H2669 Parts Breakdown

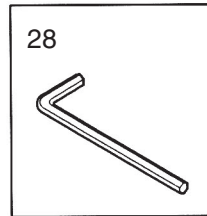
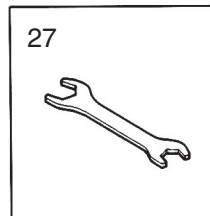
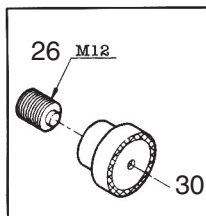
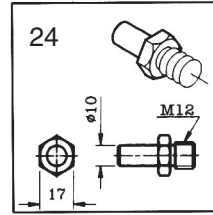
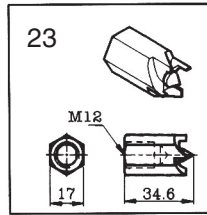
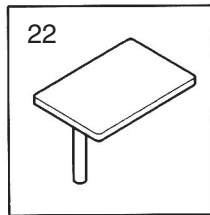
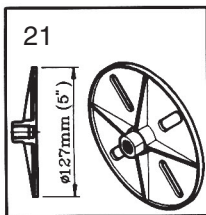
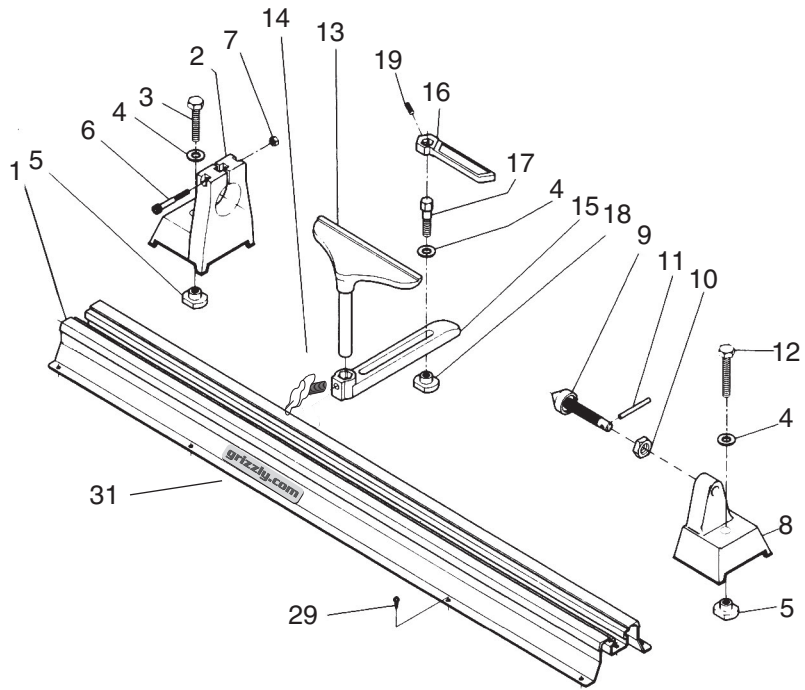

H2669 Parts List

REF	PART #	DESCRIPTION
1	PH2669001	LATHE BED
2	PH2669002	HEADSTOCK
3	PB73M	HEX BOLT M10-1.5 X 50
4	PW02	FLAT WASHER 3/8
5	PH2669005	T-NUT M10-1.5
6	PH2669006	SPECIAL CAP SCREW M6-1 X 60
7	PN01M	HEX NUT M6-1
8	PH2669008	TAILSTOCK
9	PH2669009	LIVE CENTER
10	PN32M	HEX NUT M14-2
11	PH2669011	TURNING PIN 5 X 50MM
12	PH2669012	SPECIAL HEX BOLT M10-1.5 X 60
13	PH2669013	TOOLREST
14	PH2669014	KNOB SCREW M8-2 X 16
15	PH2669015	TOOLREST BASE

REF	PART #	DESCRIPTION
16	PH2669016	LOCKDOWN LEVER
17	PH2669017	SPECIAL HEX BOLT M10-1.5 X 35
18	PH2669005	T-NUT M10-1.5
19	PSS53M	SET SCREW M5-.8 X 12
21	PH2669021	FACEPLATE
22	PH2669022	SANDING TABLE
23	PH2669023	SPUR CENTER
24	PH2669024	DRILL ADAPTER
26	PH2669026	DOG PT SET SCR M12-1.75 X 10
27	PH2669027	WRENCH 17/22MM
28	PAW05M	HEX WRENCH 5MM
29	PHTEK31M	TAP SCREW M4 X 14
30	PH2669030	SCREW CENTER
31	PH2669031	GRIZZLY LOGO

